

Instructiuni de montare si exploatare

Mounting and operating instructions

Instructions de montage

Montageanleitung

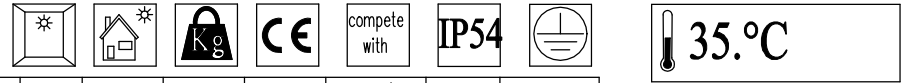

Fine Line 01 Led ● ~1 ● 80598-1/2-2 ● ●

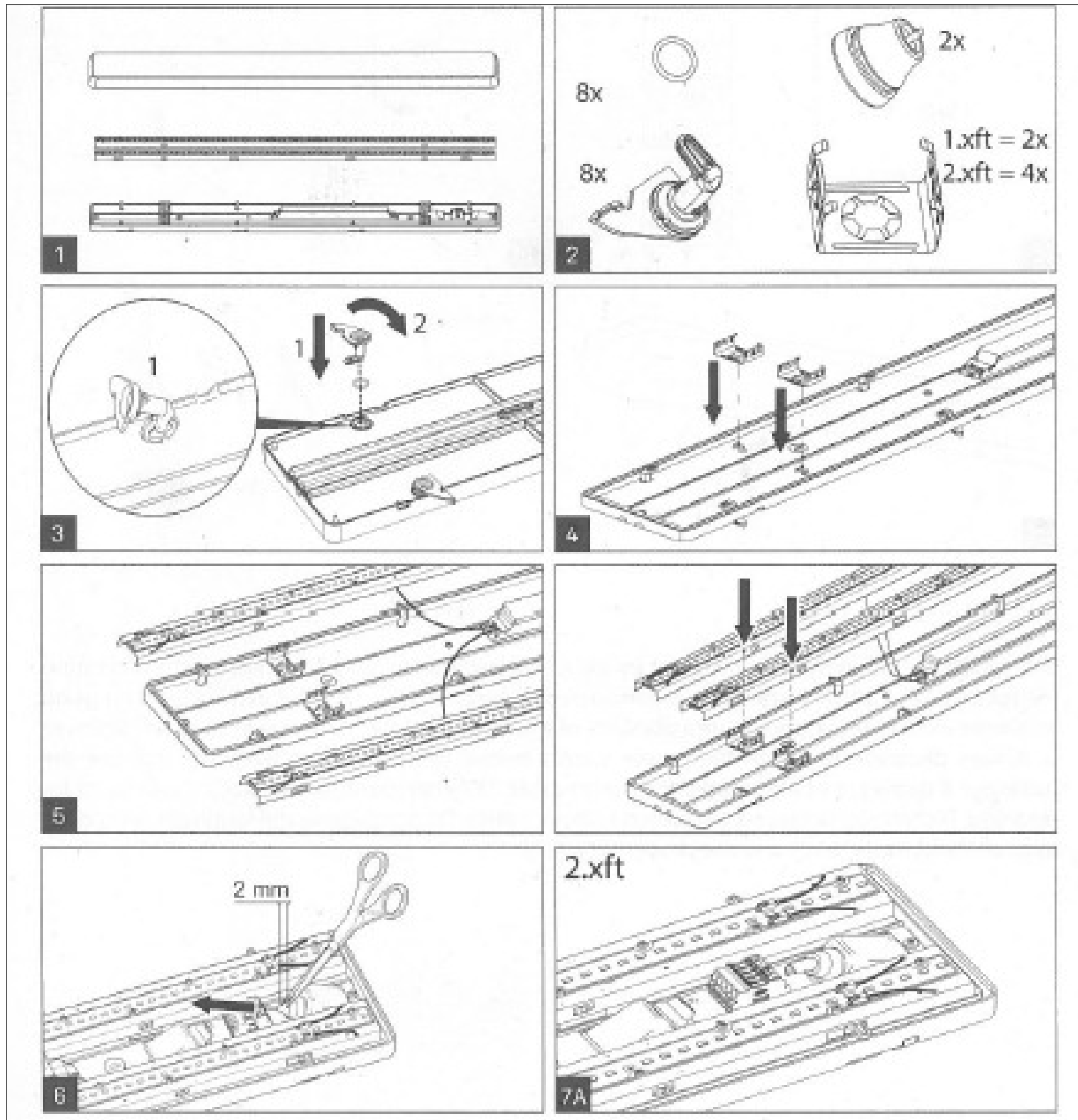
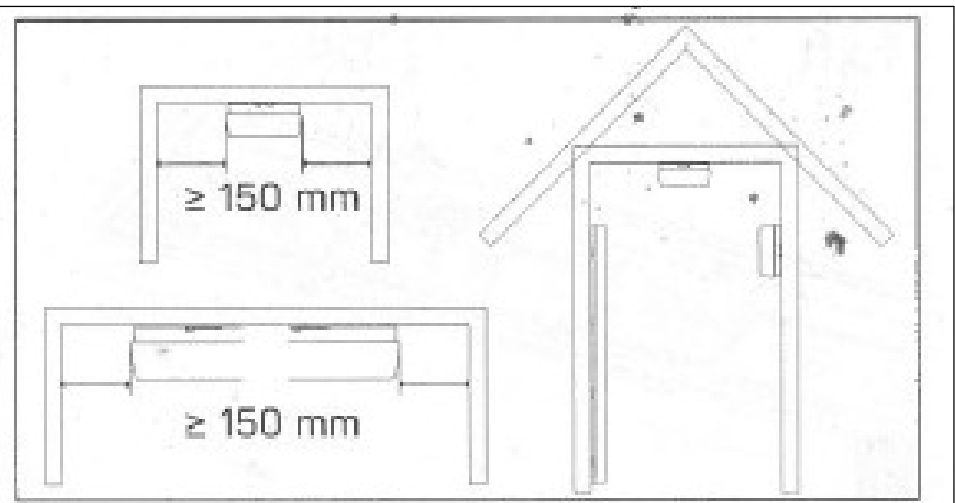
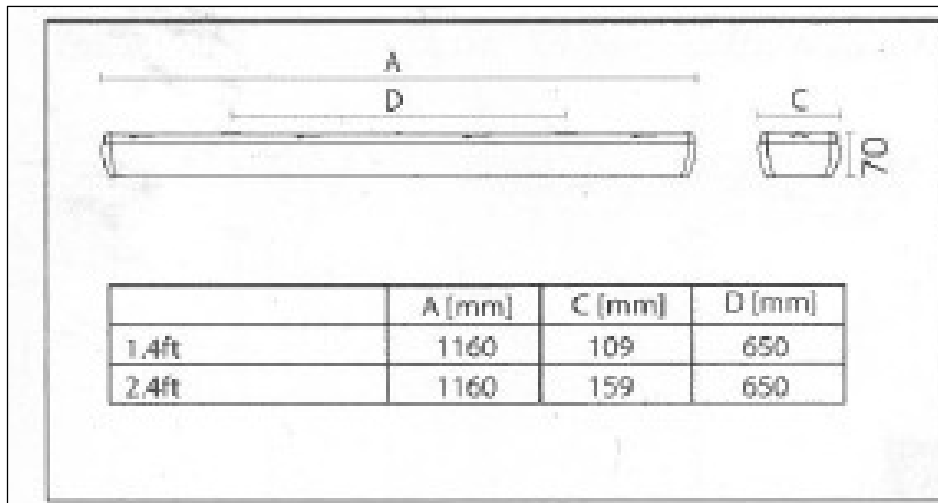

Atentie! Toate operatiile de montare si intretinere in exploatare se vor efectua in lipsa tensiunii electrice si numai de catre persoane autorizate!

 Acest simbol aplicat pe produs este in conformitate cu Directiva Europeana 2002/96/CE, privind deseurile echipamentelor electrice si electronice rezultate din dezmembrarea produselor uzate si indica faptul ca produsul face obiectul unei colectari separate. Pentru prevenirea distrugerii mediului inconjurator si sanatatii umane, va rugam sa nu eliminati acest produs ca deseuri nesortate. In vederea unei reciclari sigure din punct de vedere al mediului, utilizatorii de echipamente electrice si electronice trebuie sa predea deseurile acestora la punctele de colectare selectiva special amenajate de catre autoritatile administratiei publice locale.

*This symbol applied on the product complies with European Directive 2002/96/EC, regarding electrical and electronic waste products resulting from the dismantling and indicates that the product has a separate collection. To prevent the damages on the environment and human health, do not dispose of this product as unsorted waste. For a safe recycling, the electric and electronic equipment end-users must contact the local authorities for details concerning a safe recycling.*

Instructiuni de montare si exploatare

Mounting and operating instructions

Instructions de montage

Montageanleitung

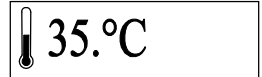

Fine Line 01 Led	●	~1	●	B0598-1/2-2	●	●
------------------	---	----	---	-------------	---	---

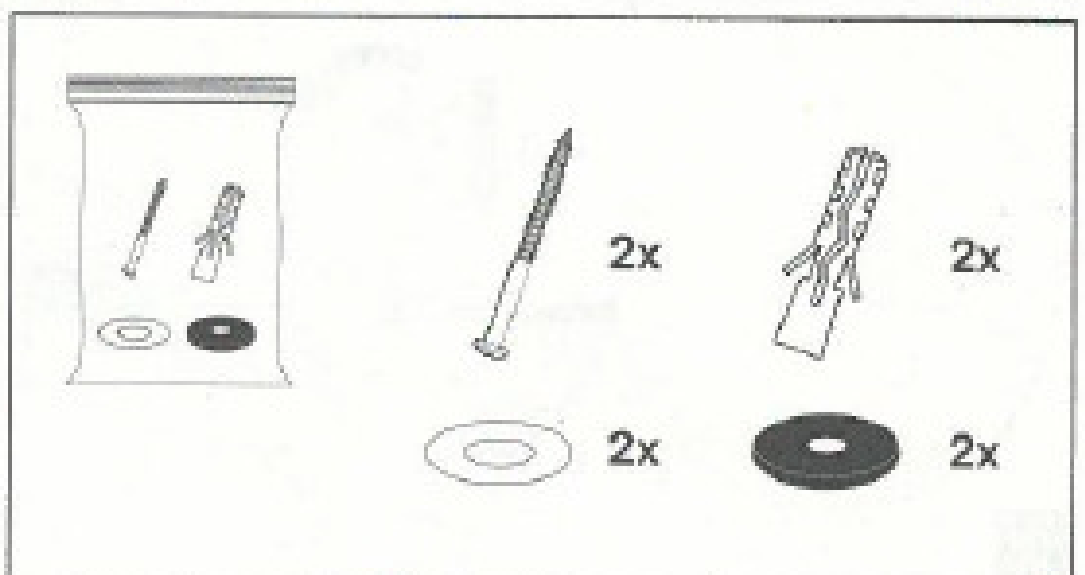
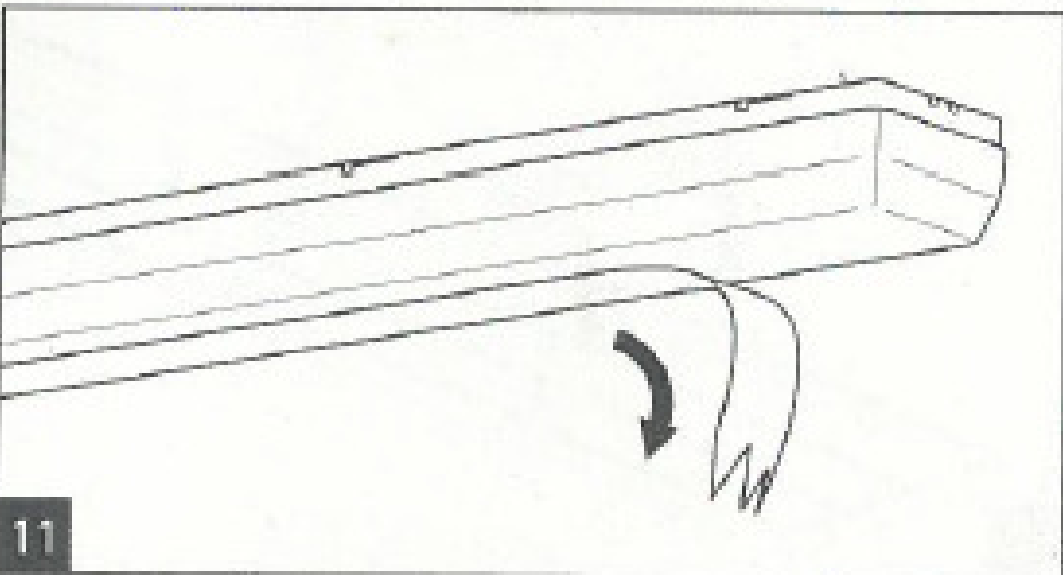
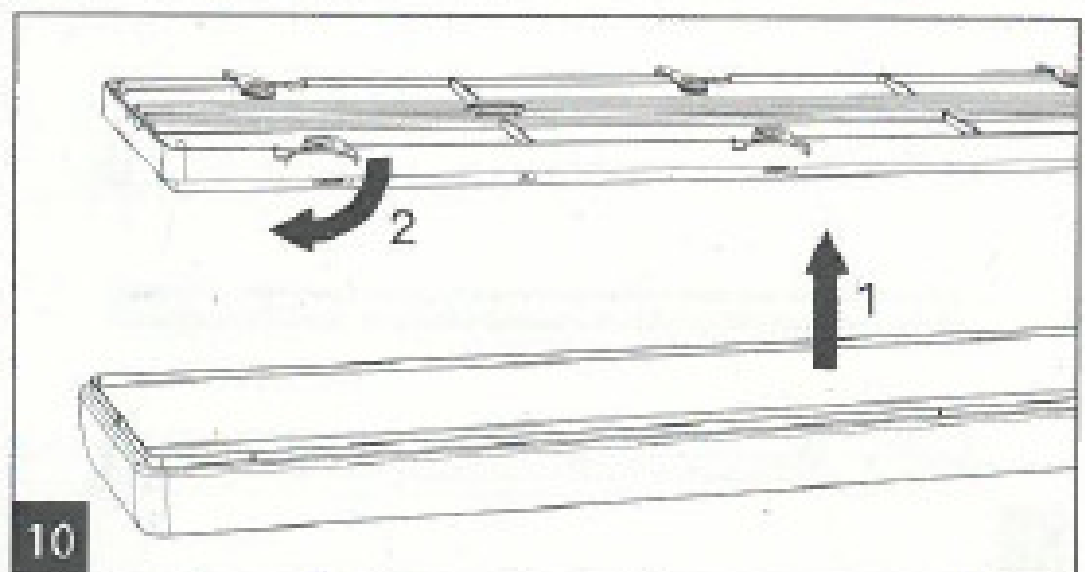
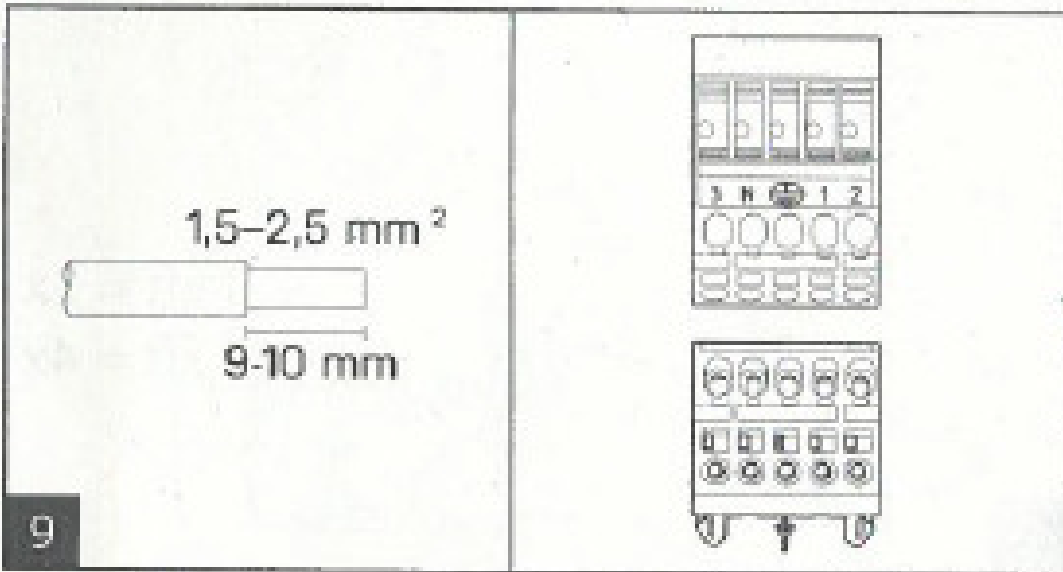
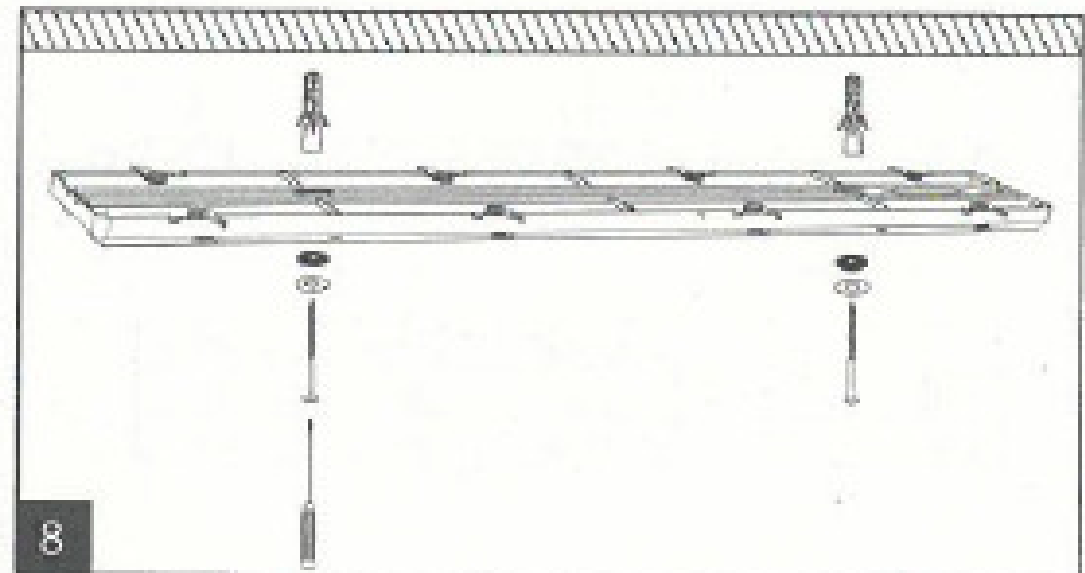
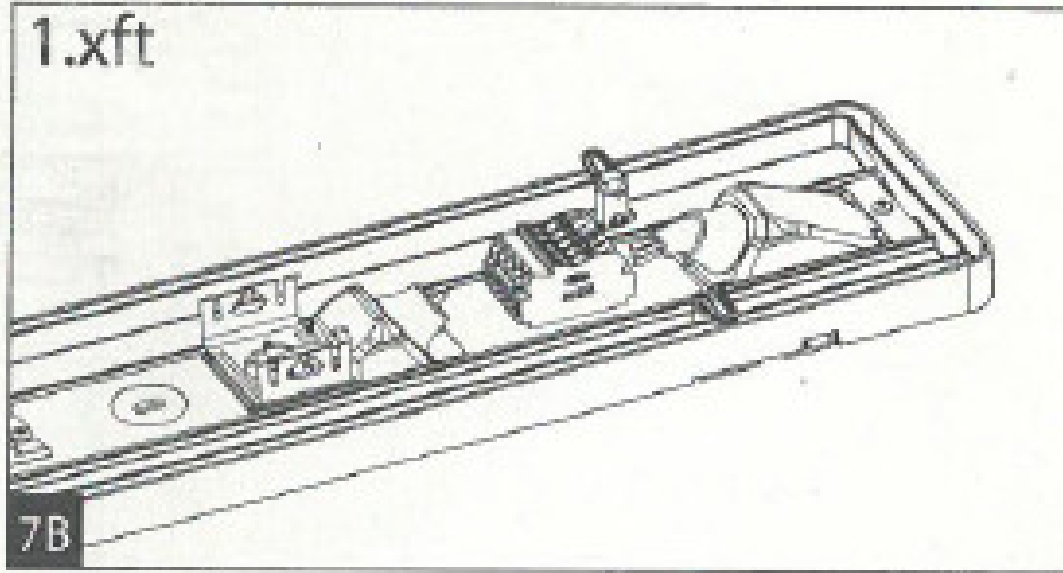

Atentie! Toate operatiile de montare si intretinere in exploatare se vor efectua in lipsa tensiunii electrice si numai de catre persoane autorizate!

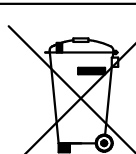
 Acest simbol aplicat pe produs este in conformitate cu Directiva Europeana 2002/96/CE, privind deseurile echipamentelor electrice si electronice rezultate din dezmembrarea produselor uzate si indica faptul ca produsul face obiectul unei colectari separate. Pentru prevenirea distrugerii mediului inconjurator si sanatatii umane, va rugam sa nu eliminati acest produs ca deseuri nesortate. In vederea unei reciclari sigure din punct de vedere al mediului, utilizatorii de echipamente electrice si electronice trebuie sa predea deseurile acestora la punctele de colectare selectiva special amenajate de catre autoritatile administratiei publice locale.

*This symbol applied on the product complies with European Directive 2002/96/EC, regarding electrical and electronic waste products resulting from the dismantling and indicates that the product has a separate collection. To prevent the damages on the environment and human health, do not dispose of this product as unsorted waste. For a safe recycling, the electric and electronic equipment end-users must contact the local authorities for details concerning a safe recycling.*